

Seat swivels to allow easy exit from the StairLift

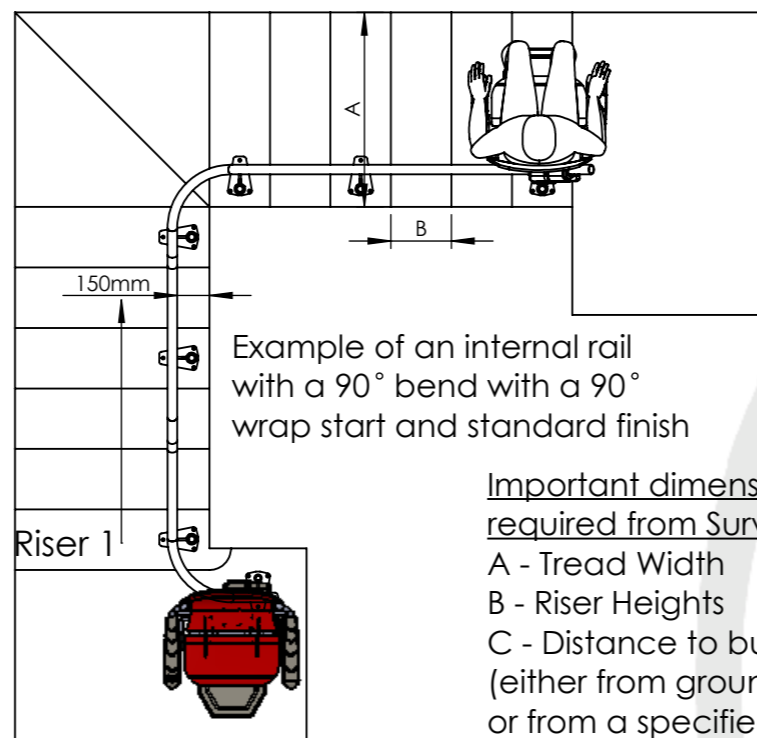

Important dimensions required from Survey:
 A - Tread Width
 B - Riser Heights
 C - Distance to bulkhead (either from ground level or from a specified riser)

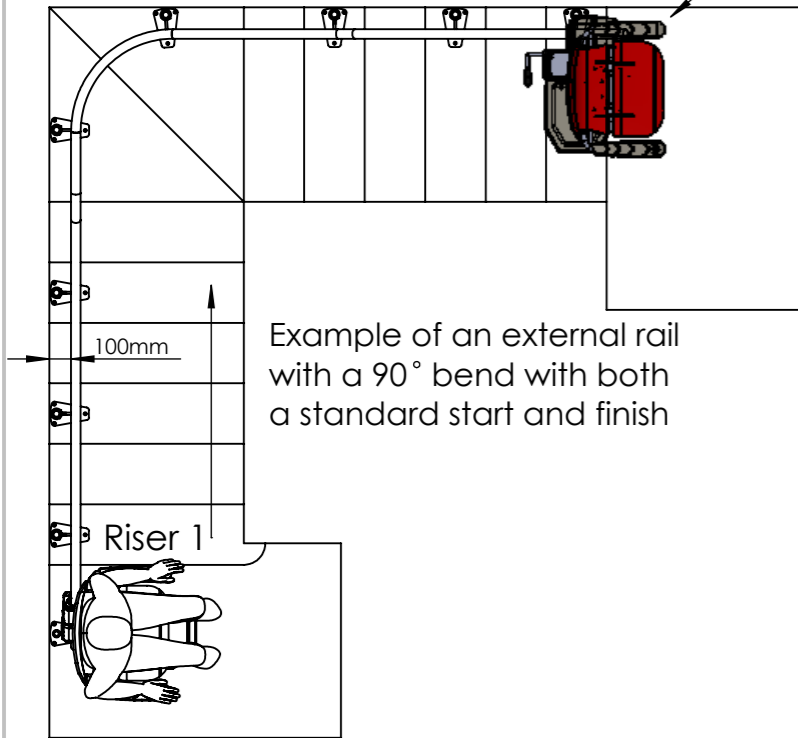
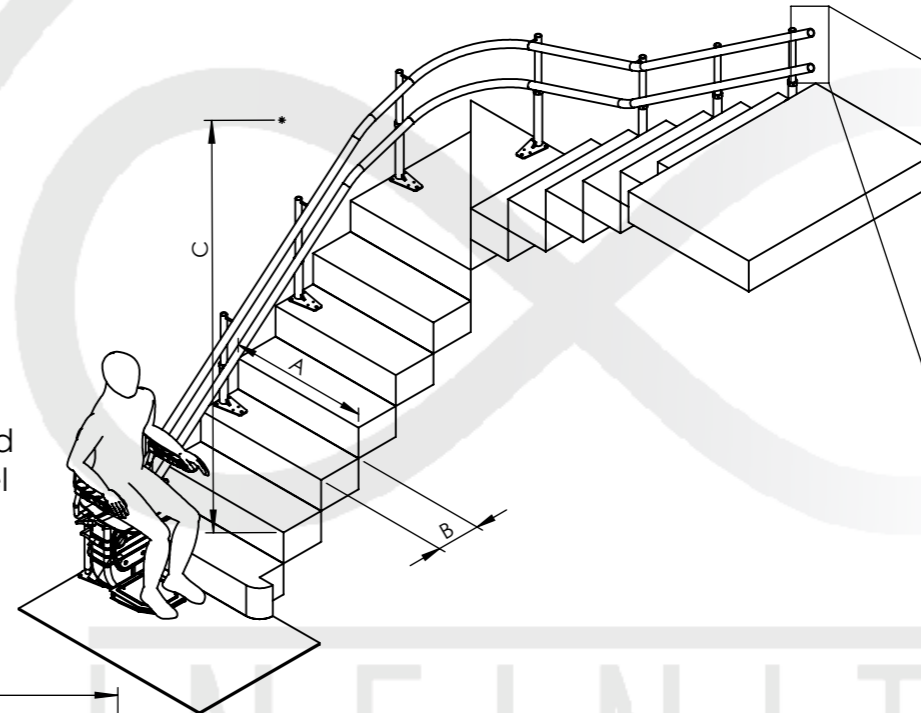
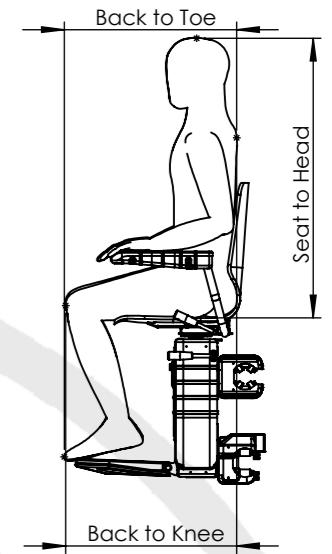
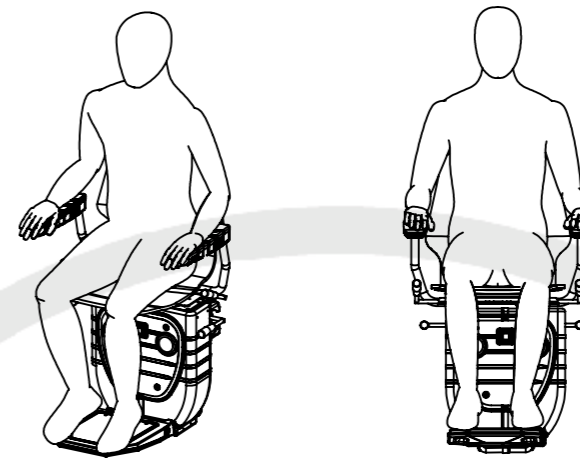

44.45mm outer diameter tubular twin rail design

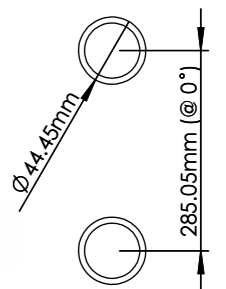

Rail Start Examples

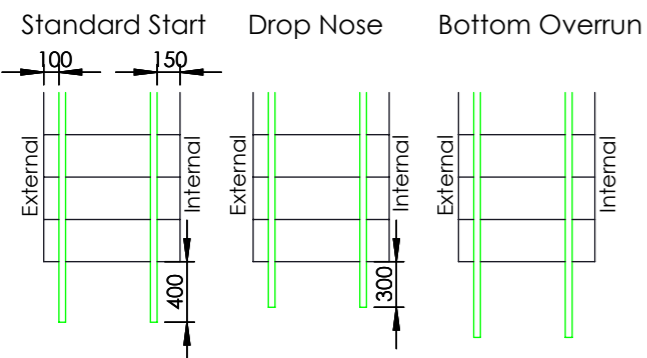

Overrun can be as long as the clearance will allow, to meet client specifications

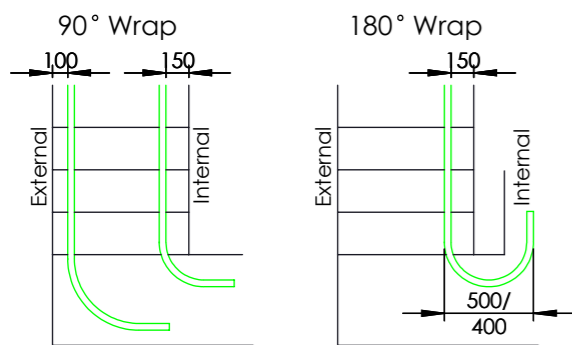

Rail Finish Examples

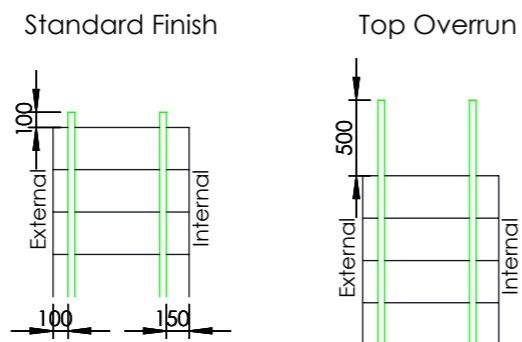

Overrun can be as long as the clearance will allow, to meet client specifications

